

BFP640F

Low profile high linearity silicon NPN RF bipolar transistor



Order now



Technical documents



Simulation



Support

Product description

The BFP640F is a RF bipolar transistor based on SiGe:C technology that is part of Infineon's established sixth generation transistor family. Its transition frequency f_T of 42 GHz and high linearity characteristics at low currents make the device suitable for energy efficiency designs at frequency as high as 8 GHz. It remains cost competitive without compromising on ease of use.



Feature list

- Minimum noise figure $NF_{min} = 0.65$ dB at 2.4 GHz, 3 V, 6 mA
- High gain $G_{ma} = 20$ dB at 2.4 GHz, 3 V, 25 mA
- $OIP_3 = 28$ dBm at 2.4 GHz, 3 V, 25 mA

Product validation

Qualified for industrial applications according to the relevant tests of JEDEC47/20/22.

Potential applications

- Low noise amplifiers (LNAs) in GNSS receivers
- LNAs in satellite radio (SDARs, DAB) receivers
- LNAs in multimedia applications such as CATV and FM radio

Device information

Table 1 Part information

Product name / Ordering code	Package	Pin configuration				Marking	Pieces / Reel
BFP640F / BFP640FH6327XTSA1	TSFP-4-1	1 = B	2 = E	3 = C	4 = E	R4s	3000

Attention: ESD (Electrostatic discharge) sensitive device, observe handling precautions

Table of contents

	Product description	1
	Feature list	1
	Product validation	1
	Potential applications	1
	Device information	1
	Table of contents	2
1	Absolute maximum ratings	3
2	Thermal characteristics	4
3	Electrical characteristics	5
3.1	DC characteristics	5
3.2	General AC characteristics	5
3.3	Frequency dependent AC characteristics	6
3.4	Characteristic DC diagrams	9
3.5	Characteristic AC diagrams	12
4	Package information TSFP-4-1	19
	Revision history	20
	Disclaimer	21

Absolute maximum ratings

1 Absolute maximum ratings

Table 2 Absolute maximum ratings at $T_A = 25\text{ °C}$ (unless otherwise specified)

Parameter	Symbol	Values		Unit	Note or test condition
		Min.	Max.		
Collector emitter voltage	V_{CEO}	-	4.1	V	Open base
			3.6		$T_A = -55\text{ °C}$, open base
Collector emitter voltage	V_{CES}		13		E-B short circuited
Collector base voltage	V_{CBO}		13		Open emitter
Emitter base voltage	V_{EBO}		1.2		Open collector
Base current	I_B		3	mA	-
Collector current	I_C		50		
Total power dissipation ¹⁾	P_{tot}		200	mW	$T_S \leq 92\text{ °C}$
Junction temperature	T_J		150	°C	-
Storage temperature	T_{Stg}	-55			

Attention: *Stresses above the max. values listed here may cause permanent damage to the device. Exposure to absolute maximum rating conditions for extended periods may affect device reliability. Exceeding only one of these values may cause irreversible damage to the integrated circuit.*

¹ T_S is the soldering point temperature. T_S is measured on the emitter lead at the soldering point of the PCB.

Thermal characteristics

2 Thermal characteristics

Table 3 Thermal resistance

Parameter	Symbol	Values			Unit	Note or test condition
		Min.	Typ.	Max.		
Junction - soldering point	R_{thJS}	-	-	290	K/W	-

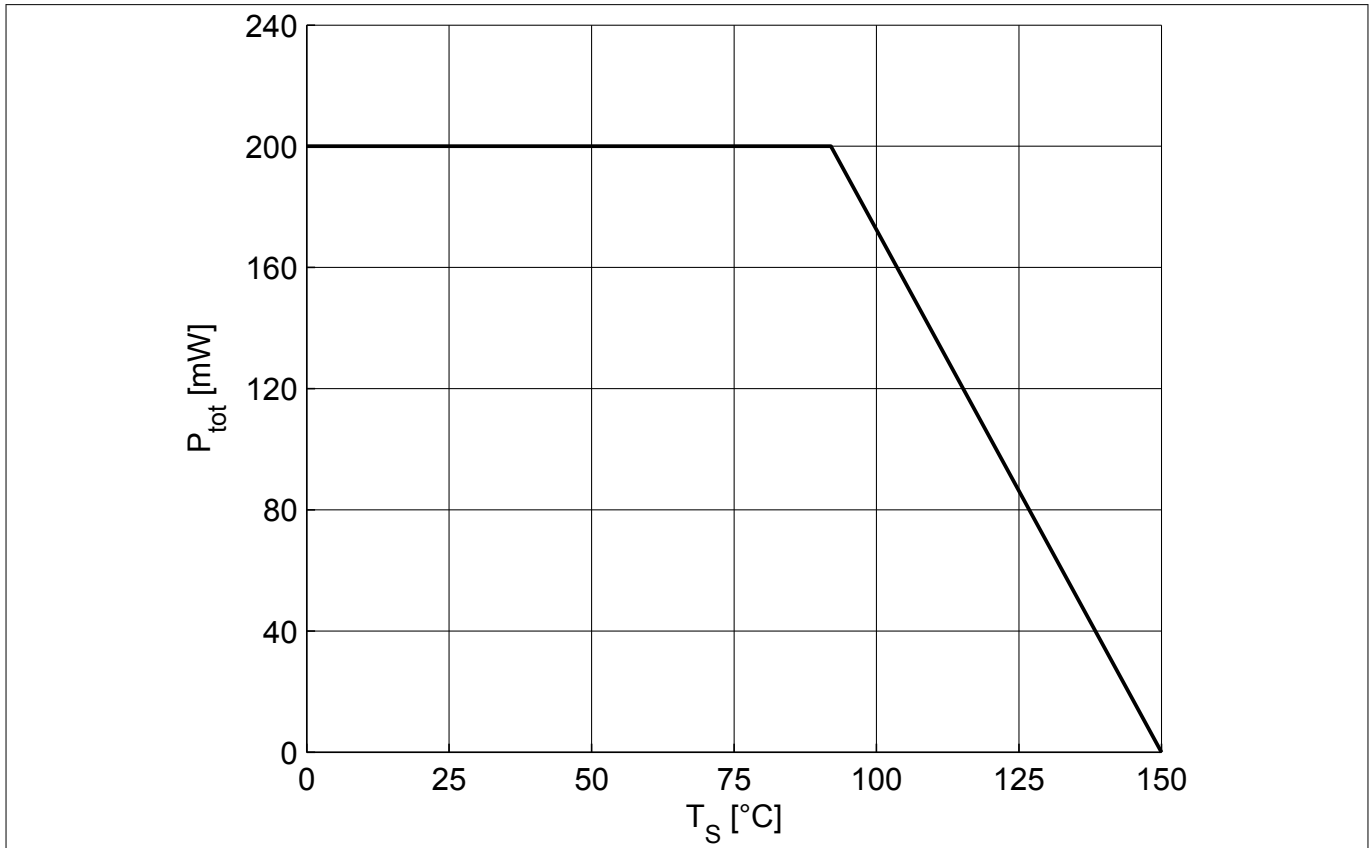

Figure 1 Total power dissipation $P_{tot} = f(T_S)$

Electrical characteristics

3 Electrical characteristics

3.1 DC characteristics

Table 4 DC characteristics at $T_A = 25\text{ °C}$

Parameter	Symbol	Values			Unit	Note or test condition
		Min.	Typ.	Max.		
Collector emitter breakdown voltage	$V_{(BR)CEO}$	4.1	4.7	–	V	$I_C = 1\text{ mA}$, $I_B = 0$, open base
Collector emitter leakage current	I_{CES}	–	1	400 ²⁾	nA	$V_{CE} = 13\text{ V}$, $V_{BE} = 0$, E-B short circuited
			1	40 ²⁾		$V_{CE} = 5\text{ V}$, $V_{BE} = 0$, E-B short circuited
Collector base leakage current	I_{CBO}		1	40 ²⁾		$V_{CB} = 5\text{ V}$, $I_E = 0$, open emitter
Emitter base leakage current	I_{EBO}		1	40 ²⁾		$V_{EB} = 0.5\text{ V}$, $I_C = 0$, open collector
DC current gain	h_{FE}	110	180	270		$V_{CE} = 3\text{ V}$, $I_C = 30\text{ mA}$, pulse measured

3.2 General AC characteristics

Table 5 General AC characteristics at $T_A = 25\text{ °C}$

Parameter	Symbol	Values			Unit	Note or test condition
		Min.	Typ.	Max.		
Transition frequency	f_T	–	42	–	GHz	$V_{CE} = 3\text{ V}$, $I_C = 30\text{ mA}$, $f = 1\text{ GHz}$
Collector base capacitance	C_{CB}		0.09		pF	$V_{CB} = 3\text{ V}$, $V_{BE} = 0$, $f = 1\text{ MHz}$, emitter grounded
Collector emitter capacitance	C_{CE}		0.2			$V_{CE} = 3\text{ V}$, $V_{BE} = 0$, $f = 1\text{ MHz}$, base grounded
Emitter base capacitance	C_{EB}		0.47			$V_{EB} = 0.5\text{ V}$, $V_{CB} = 0$, $f = 1\text{ MHz}$, collector grounded

² Maximum values not limited by the device but by the short cycle time of the 100% test.

Electrical characteristics

3.3 Frequency dependent AC characteristics

Measurement setup is a test fixture with Bias-T's in a 50 Ω system, $T_A = 25\text{ °C}$.

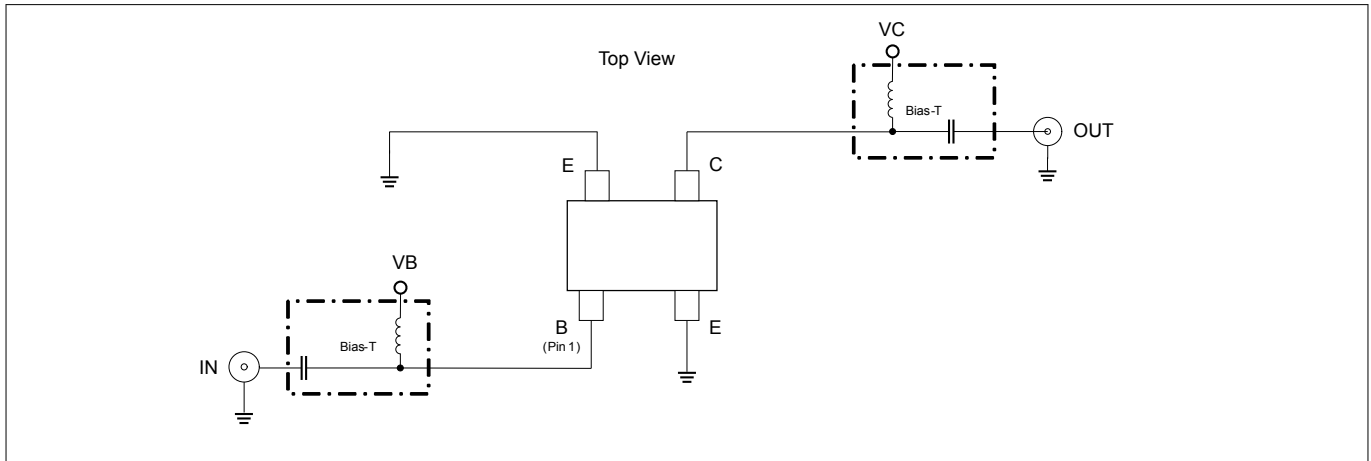

Figure 2 Testing circuit

Table 6 AC characteristics, $V_{CE} = 3\text{ V}$, $f = 450\text{ MHz}$

Parameter	Symbol	Values			Unit	Note or test condition
		Min.	Typ.	Max.		
Power gain		-		-	dB	$I_C = 25\text{ mA}$
<ul style="list-style-type: none"> Maximum power gain Transducer gain 	G_{ms} $ S_{21} ^2$		33 31			
Noise figure						$I_C = 6\text{ mA}$
<ul style="list-style-type: none"> Minimum noise figure Associated gain 	NF_{min} G_{ass}		0.55 26			
Linearity					dBm	$I_C = 25\text{ mA}$, $Z_S = Z_L = 50\text{ }\Omega$
<ul style="list-style-type: none"> 3rd order intercept point at output 1 dB gain compression point at output 	OIP_3 OP_{1dB}		23.5 10.5			

Table 7 AC characteristics, $V_{CE} = 3\text{ V}$, $f = 900\text{ MHz}$

Parameter	Symbol	Values			Unit	Note or test condition
		Min.	Typ.	Max.		
Power gain		-		-	dB	$I_C = 25\text{ mA}$
<ul style="list-style-type: none"> Maximum power gain Transducer gain 	G_{ms} $ S_{21} ^2$		28.5 26.5			
Noise figure						$I_C = 6\text{ mA}$
<ul style="list-style-type: none"> Minimum noise figure Associated gain 	NF_{min} G_{ass}		0.55 23.5			
Linearity					dBm	$I_C = 25\text{ mA}$, $Z_S = Z_L = 50\text{ }\Omega$
<ul style="list-style-type: none"> 3rd order intercept point at output 1 dB gain compression point at output 	OIP_3 OP_{1dB}		26 12.5			

Electrical characteristics

Table 8 AC characteristics, $V_{CE} = 3\text{ V}$, $f = 1.5\text{ GHz}$

Parameter	Symbol	Values			Unit	Note or test condition
		Min.	Typ.	Max.		
Power gain	G_{ms} $ S_{21} ^2$	-	25	-	dB	$I_C = 25\text{ mA}$
<ul style="list-style-type: none"> Maximum power gain Transducer gain 			22.5			
Noise figure	NF_{min} G_{ass}		0.6			$I_C = 6\text{ mA}$
<ul style="list-style-type: none"> Minimum noise figure Associated gain 			20.5			
Linearity	OIP_3 OP_{1dB}		26		dBm	$I_C = 25\text{ mA}$, $Z_S = Z_L = 50\ \Omega$
<ul style="list-style-type: none"> 3rd order intercept point at output 1 dB gain compression point at output 			12			

Table 9 AC characteristics, $V_{CE} = 3\text{ V}$, $f = 1.9\text{ GHz}$

Parameter	Symbol	Values			Unit	Note or test condition
		Min.	Typ.	Max.		
Power gain	G_{ms} $ S_{21} ^2$	-	23	-	dB	$I_C = 25\text{ mA}$
<ul style="list-style-type: none"> Maximum power gain Transducer gain 			20.5			
Noise figure	NF_{min} G_{ass}		0.6			$I_C = 6\text{ mA}$
<ul style="list-style-type: none"> Minimum noise figure Associated gain 			19			
Linearity	OIP_3 OP_{1dB}		27		dBm	$I_C = 25\text{ mA}$, $Z_S = Z_L = 50\ \Omega$
<ul style="list-style-type: none"> 3rd order intercept point at output 1 dB gain compression point at output 			12.5			

Table 10 AC characteristics, $V_{CE} = 3\text{ V}$, $f = 2.4\text{ GHz}$

Parameter	Symbol	Values			Unit	Note or test condition
		Min.	Typ.	Max.		
Power gain	G_{ma} $ S_{21} ^2$	-	20	-	dB	$I_C = 25\text{ mA}$
<ul style="list-style-type: none"> Maximum power gain Transducer gain 			18.5			
Noise figure	NF_{min} G_{ass}		0.65			$I_C = 6\text{ mA}$
<ul style="list-style-type: none"> Minimum noise figure Associated gain 			17			
Linearity	OIP_3 OP_{1dB}		28		dBm	$I_C = 25\text{ mA}$, $Z_S = Z_L = 50\ \Omega$
<ul style="list-style-type: none"> 3rd order intercept point at output 1 dB gain compression point at output 			12.5			

Electrical characteristics

Table 11 AC characteristics, $V_{CE} = 3\text{ V}$, $f = 3.5\text{ GHz}$

Parameter	Symbol	Values			Unit	Note or test condition
		Min.	Typ.	Max.		
Power gain	G_{ma} $ S_{21} ^2$	-	16.5	-	dB	$I_C = 25\text{ mA}$
• Maximum power gain			15.5			
• Transducer gain						
Noise figure	NF_{min} G_{ass}		0.75		dB	$I_C = 6\text{ mA}$
• Minimum noise figure			14			
• Associated gain						
Linearity	OIP_3 OP_{1dB}		27.5		dBm	$I_C = 25\text{ mA}$, $Z_S = Z_L = 50\ \Omega$
• 3rd order intercept point at output			12			
• 1 dB gain compression point at output						

Table 12 AC characteristics, $V_{CE} = 3\text{ V}$, $f = 5.5\text{ GHz}$

Parameter	Symbol	Values			Unit	Note or test condition
		Min.	Typ.	Max.		
Power gain	G_{ma} $ S_{21} ^2$	-	12.5	-	dB	$I_C = 25\text{ mA}$
• Maximum power gain			11.5			
• Transducer gain						
Noise figure	NF_{min} G_{ass}		1.0		dB	$I_C = 6\text{ mA}$
• Minimum noise figure			11			
• Associated gain						
Linearity	OIP_3 OP_{1dB}		27.5		dBm	$I_C = 25\text{ mA}$, $Z_S = Z_L = 50\ \Omega$
• 3rd order intercept point at output			12.5			
• 1 dB gain compression point at output						

Note: $G_{ms} = |S_{21} / S_{12}|$ for $k < 1$; $G_{ma} = |S_{21} / S_{12}| (k - (k^2 - 1)^{1/2})$ for $k > 1$. In order to get the NF_{min} values stated in this chapter, the test fixture losses have been subtracted from all measured results. OIP_3 value depends on termination of all intermodulation frequency components. Termination used for this measurement is $50\ \Omega$ from 0.2 MHz to 12 GHz.

Electrical characteristics

3.4 Characteristic DC diagrams

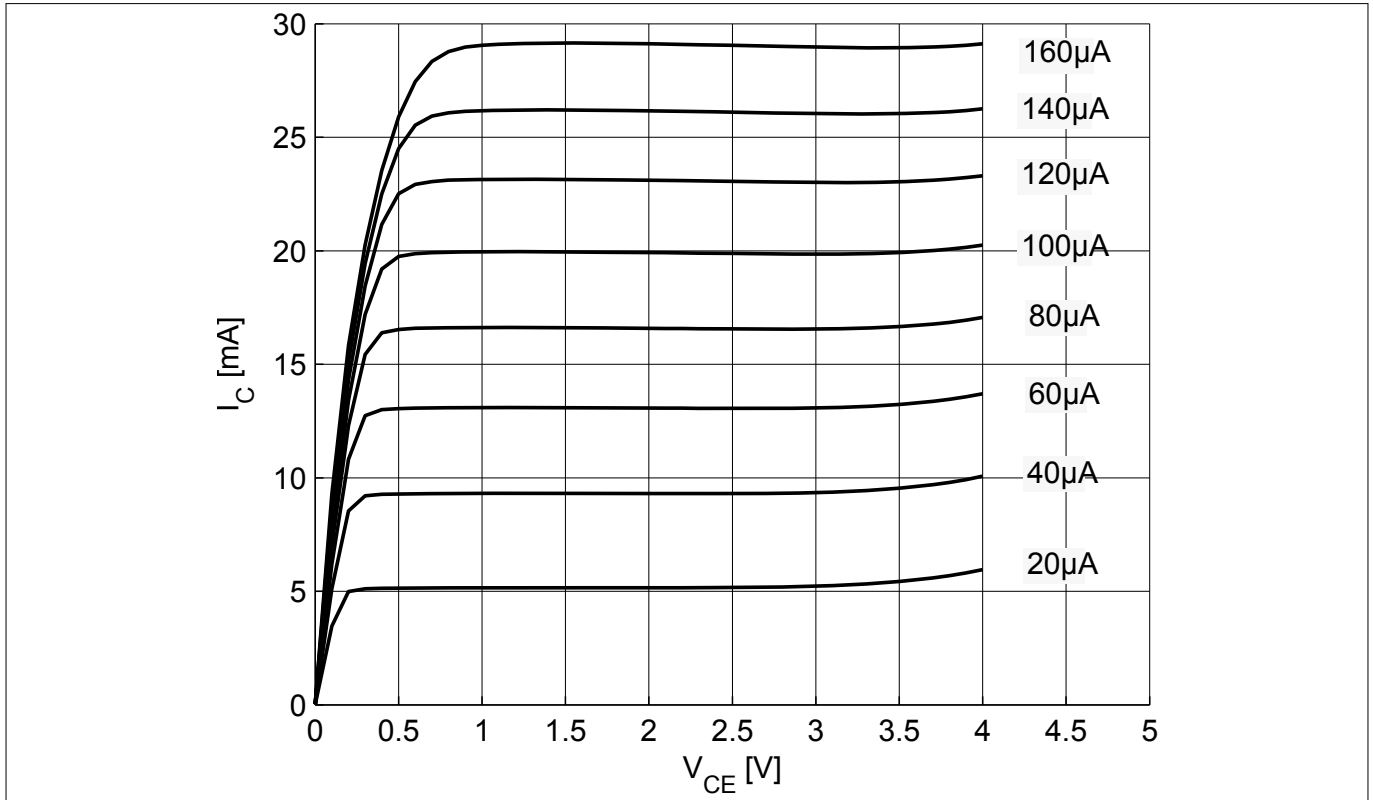

Figure 3 Collector current vs. collector emitter voltage $I_C = f(V_{CE}), I_B = \text{parameter}$

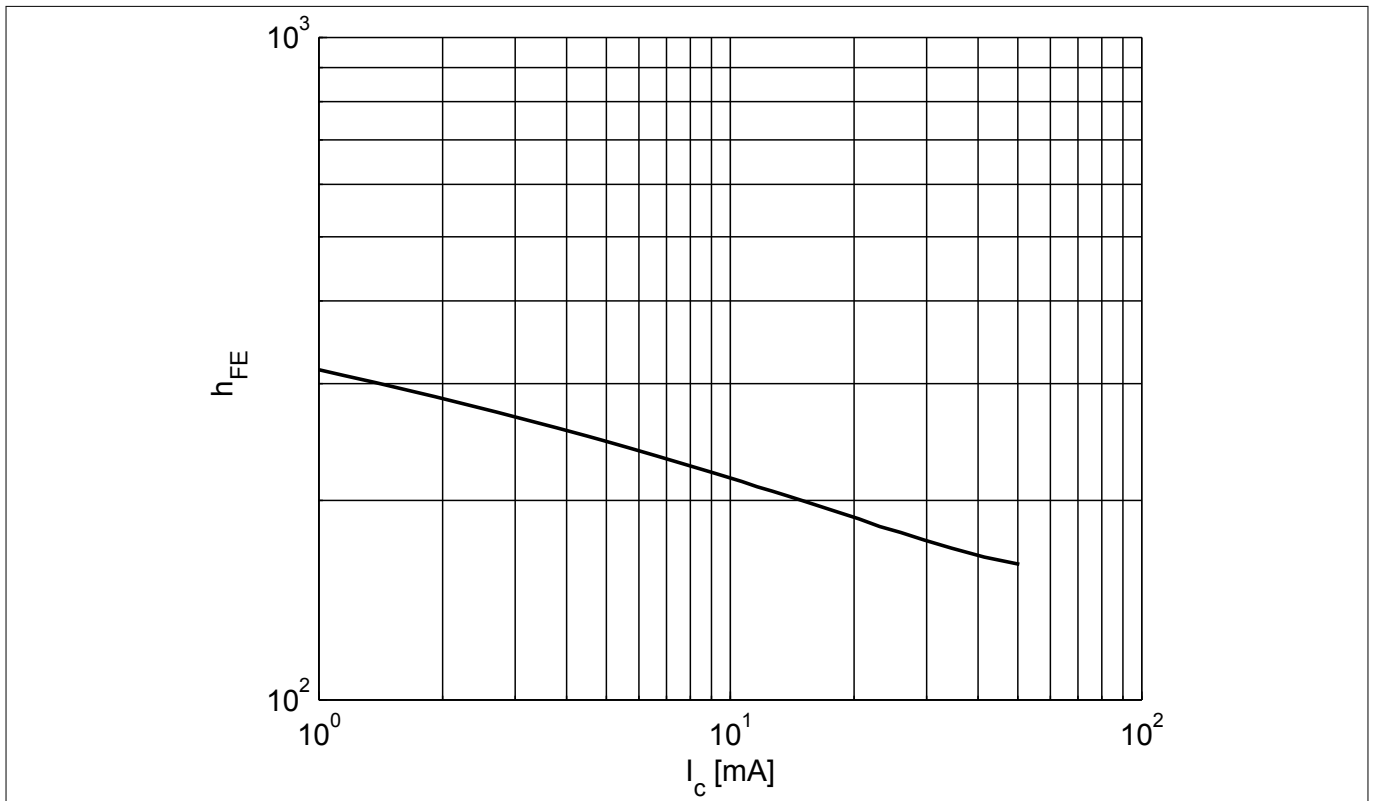

Figure 4 DC current gain $h_{FE} = f(I_C), V_{CE} = 3 \text{ V}$

Electrical characteristics

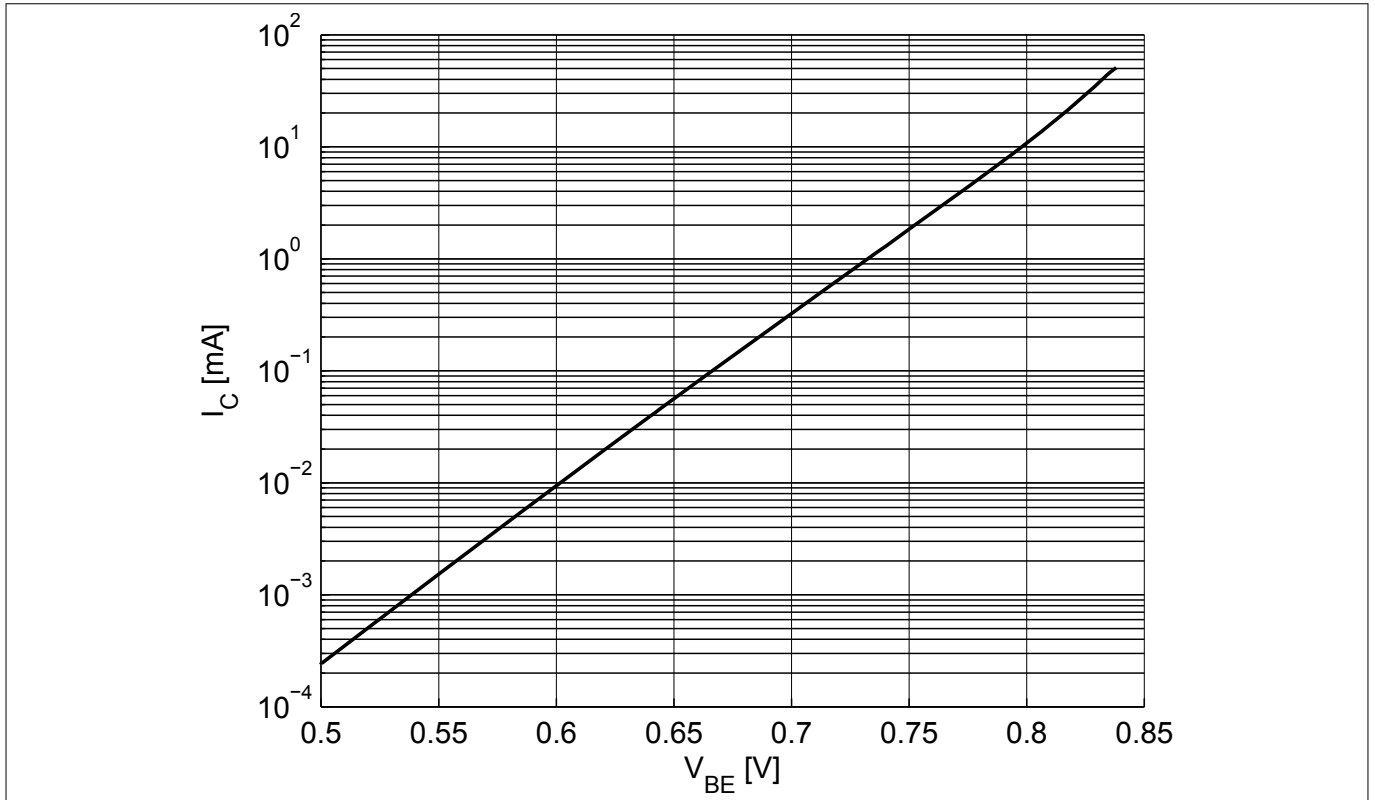

Figure 5 Collector current vs. base emitter forward voltage $I_C = f(V_{BE}), V_{CE} = 2\text{ V}$

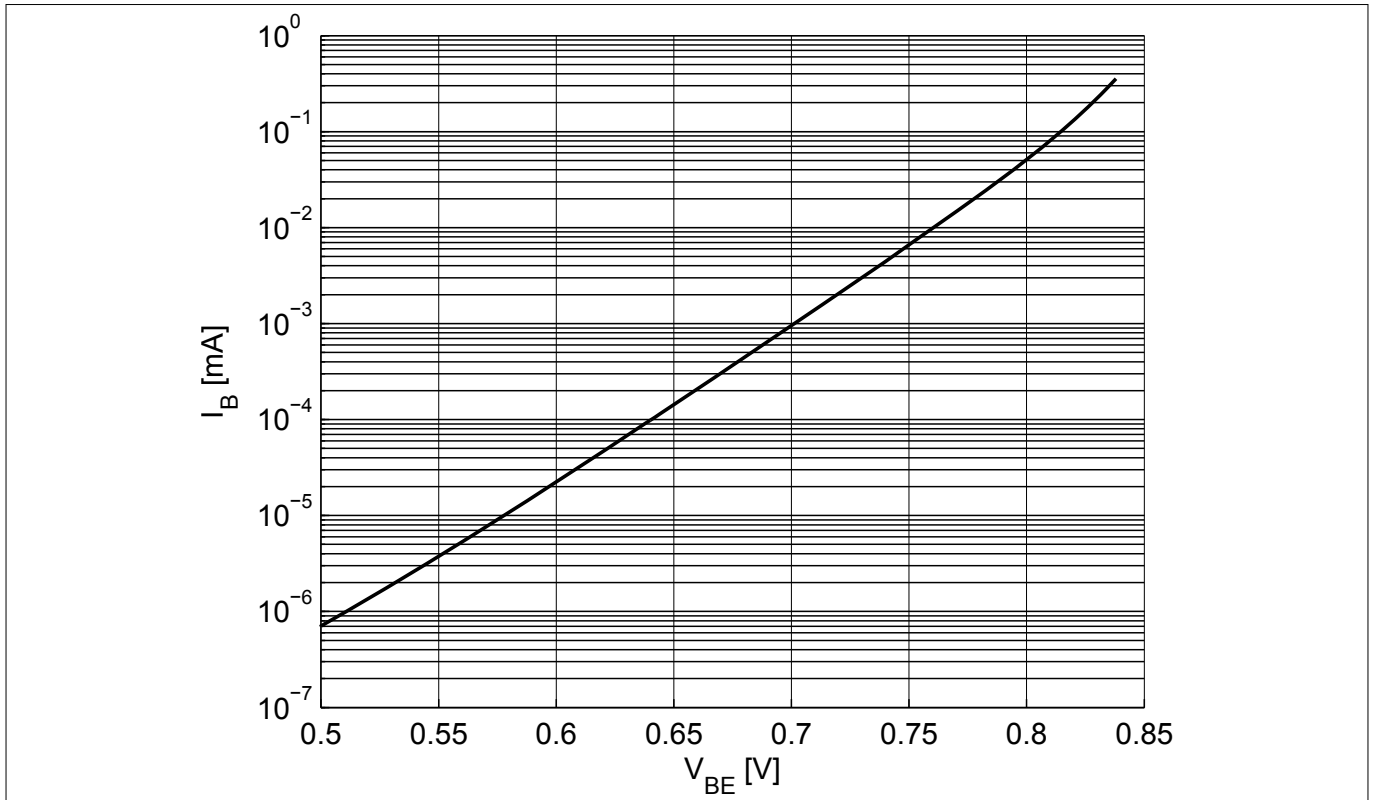

Figure 6 Base current vs. base emitter forward voltage $I_B = f(V_{BE}), V_{CE} = 2\text{ V}$

Electrical characteristics

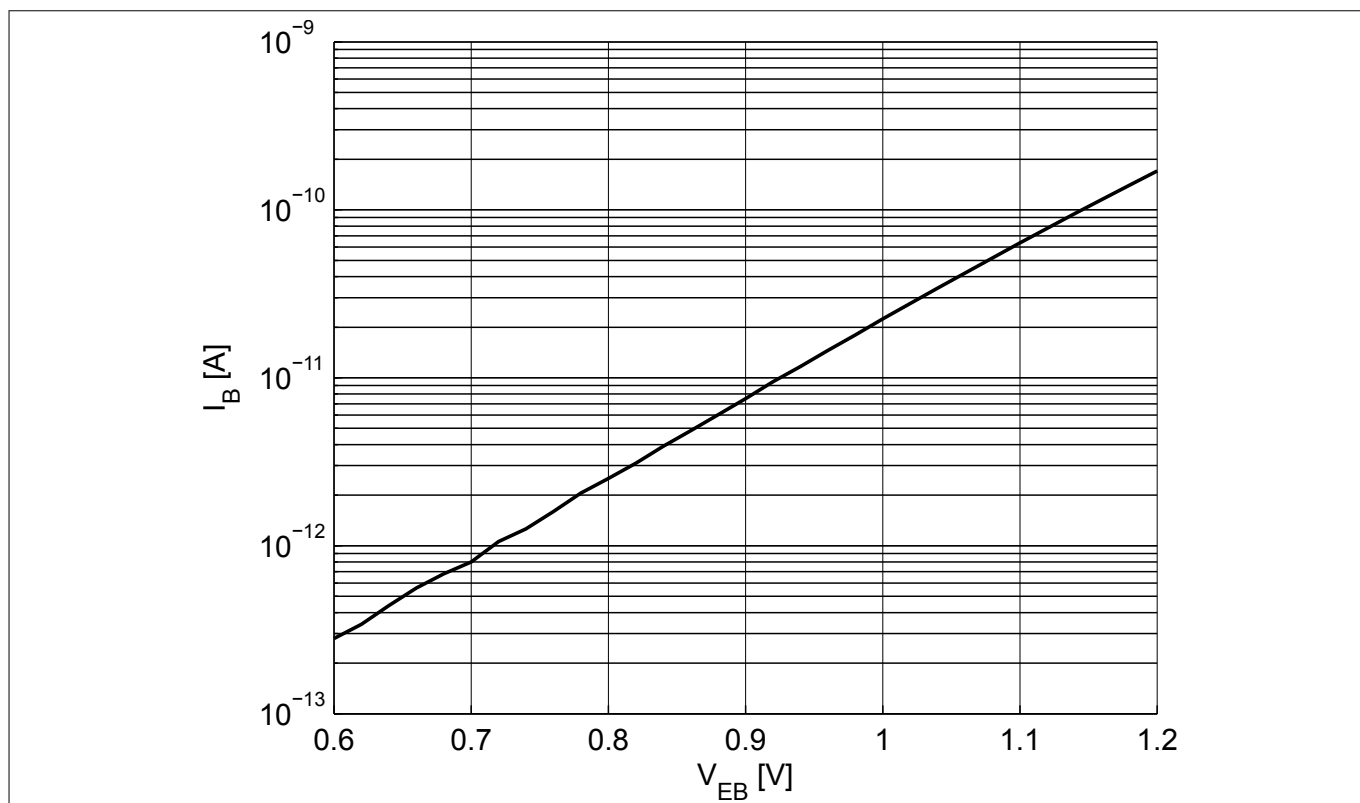

Figure 7 Base current vs. base emitter reverse voltage $I_B = f(V_{EB})$, $V_{CE} = 2\text{ V}$

Electrical characteristics

3.5 Characteristic AC diagrams

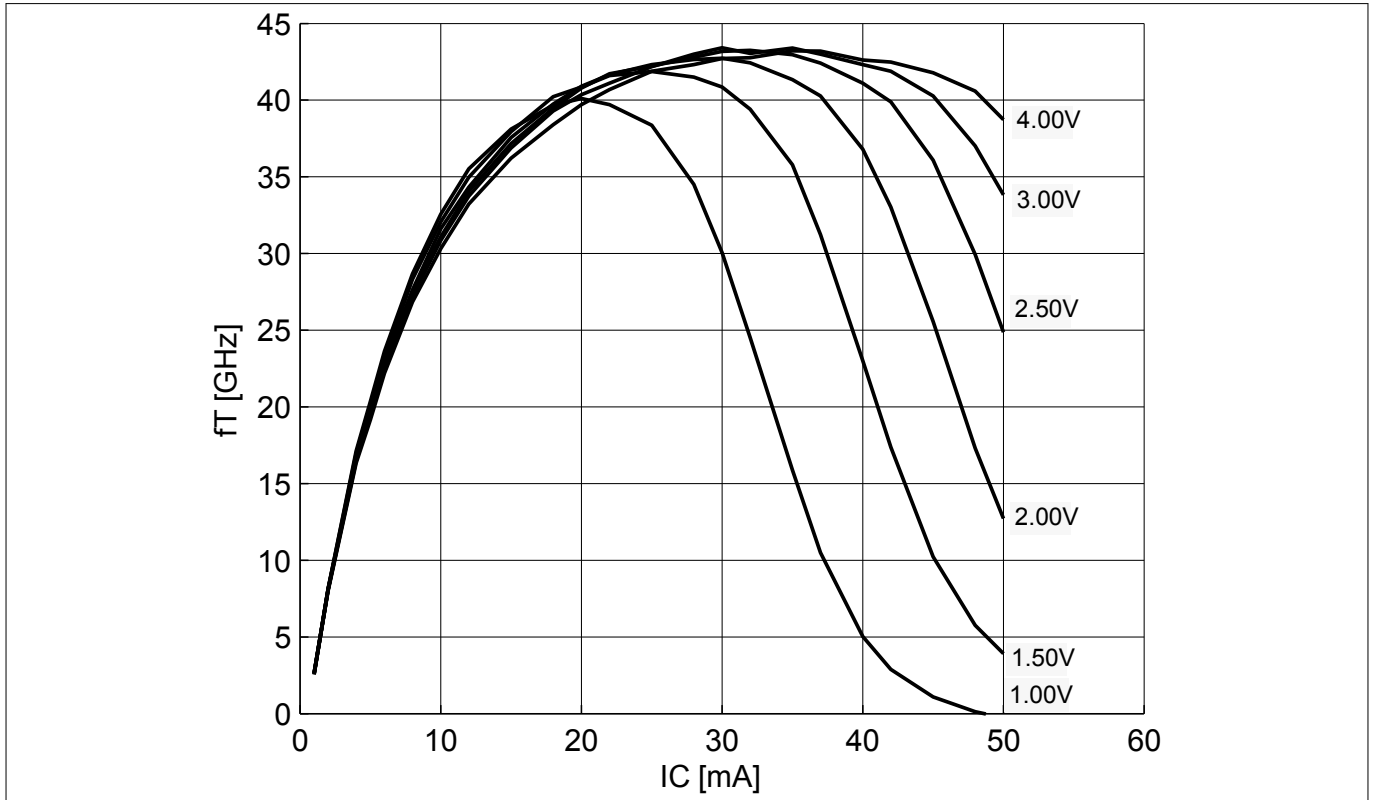

Figure 8 Transition frequency $f_T = f(I_C)$, $f = 1 \text{ GHz}$, $V_{CE} = \text{parameter}$

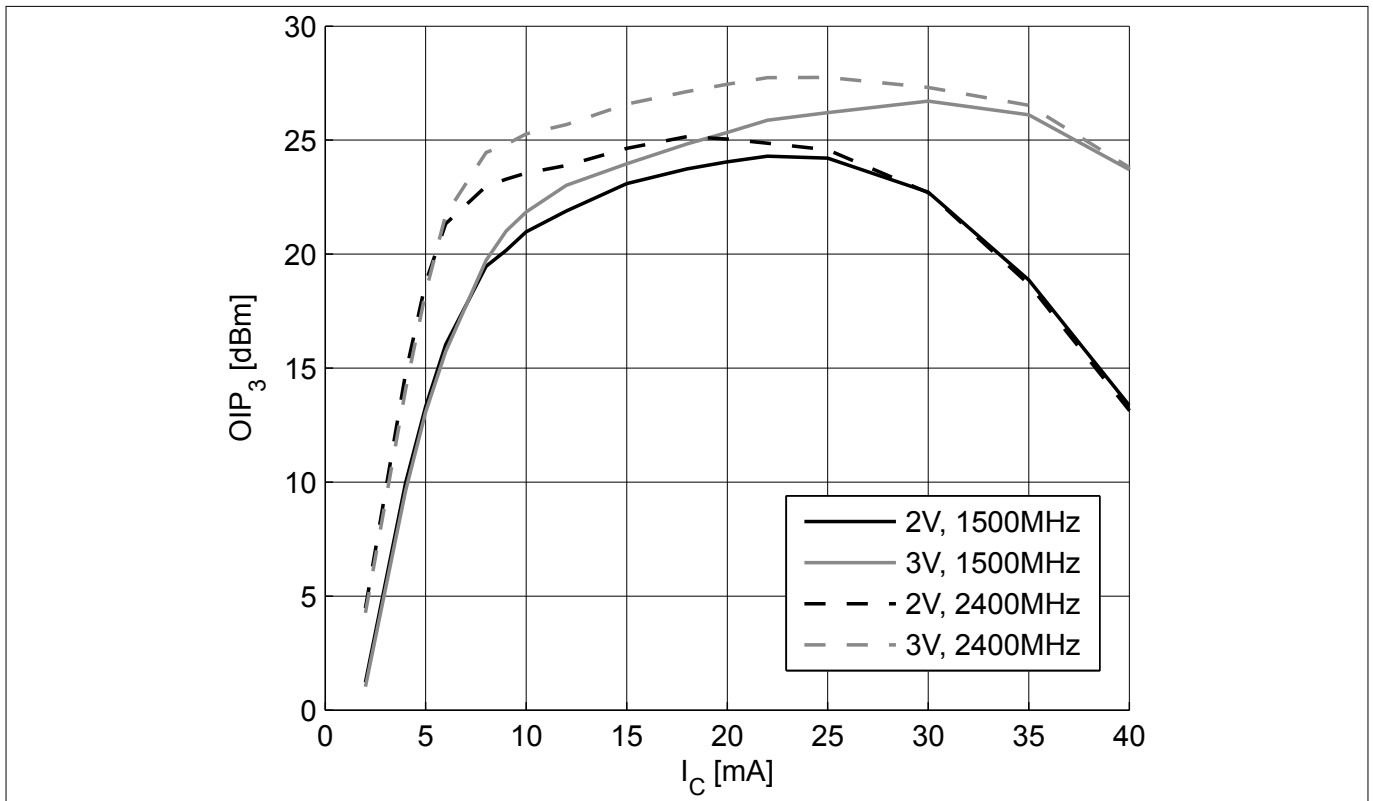

Figure 9 3rd order intercept point $OIP_3 = f(I_C)$, $Z_S = Z_L = 50 \Omega$, V_{CE} , $f = \text{parameters}$

Electrical characteristics

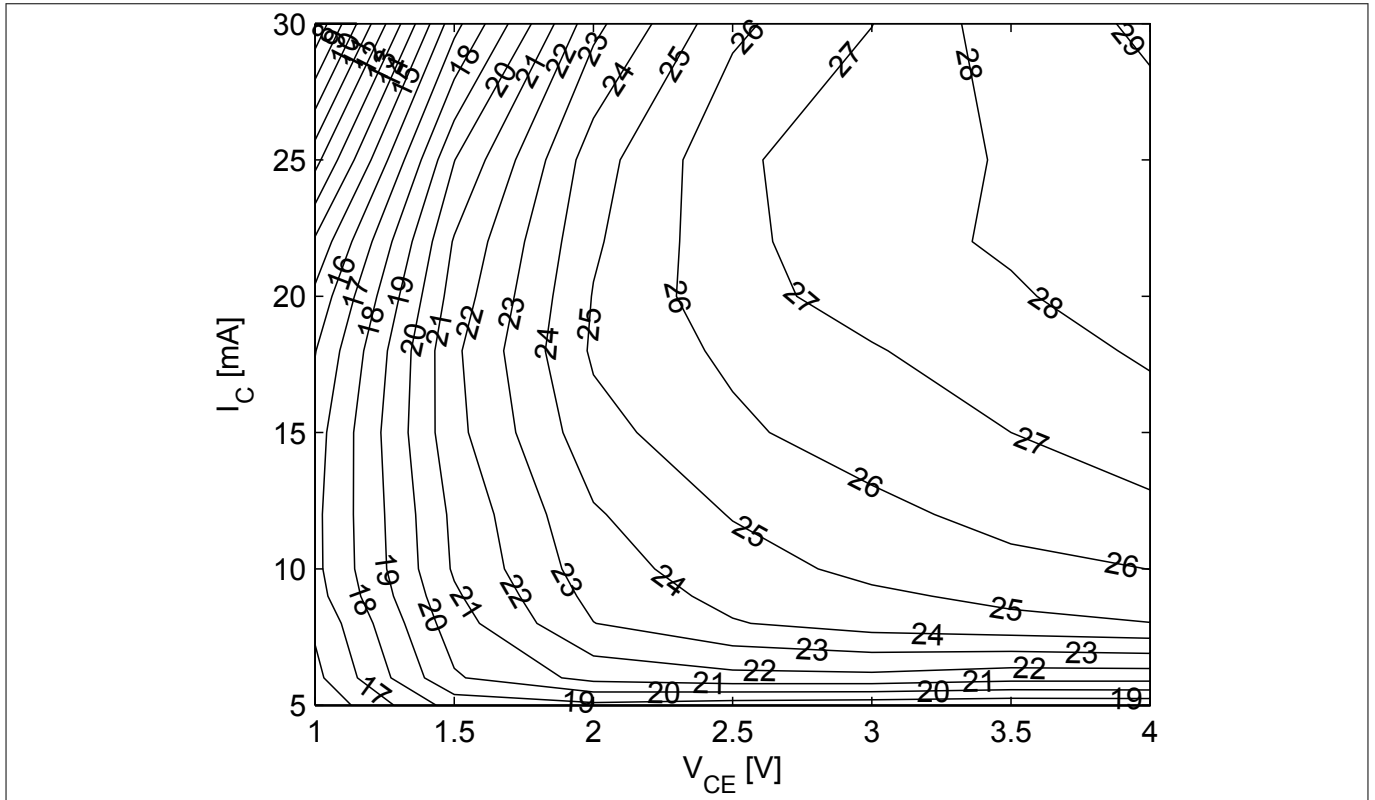

Figure 10 3rd order intercept point at output OIP_3 [dBm] = $f(I_C, V_{CE})$, $Z_S = Z_L = 50 \Omega$, $f = 2.4$ GHz

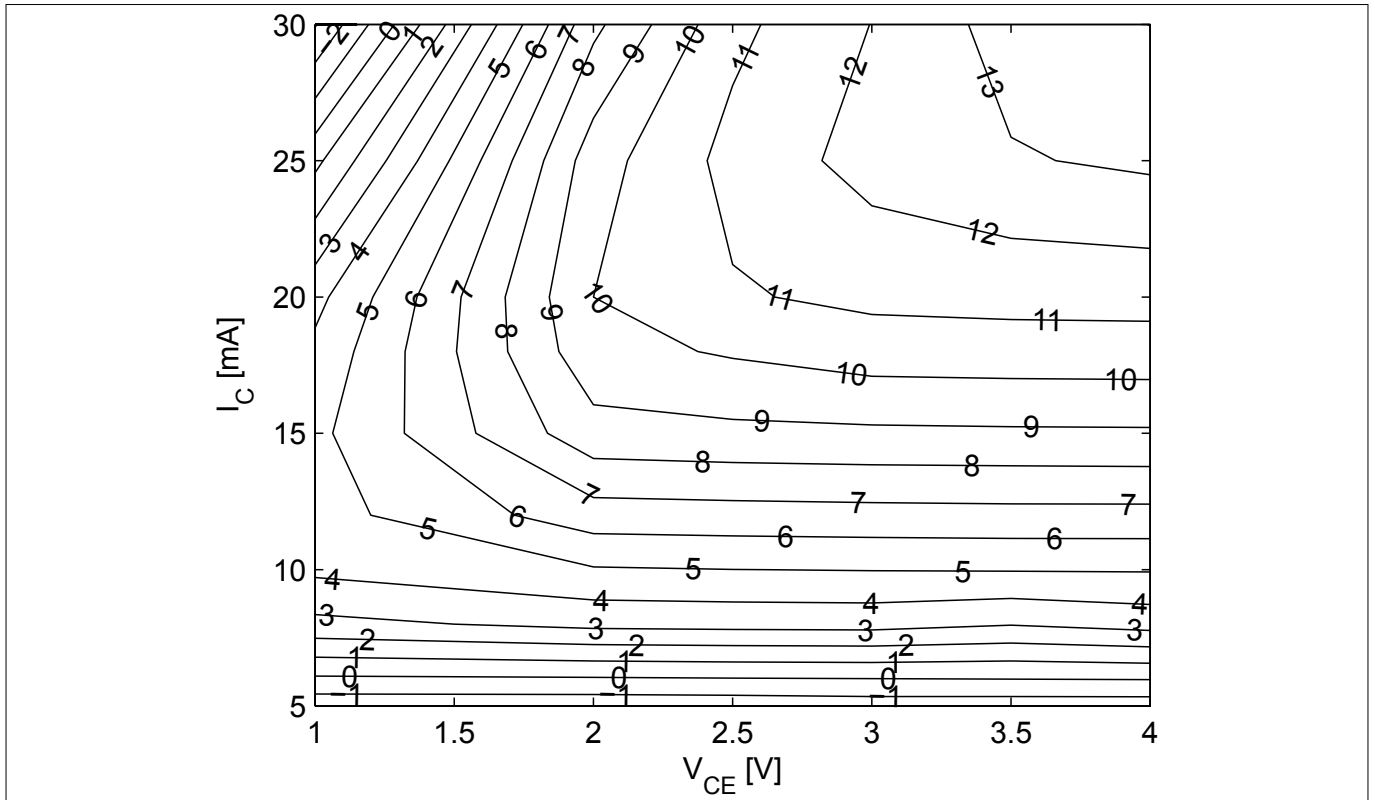

Figure 11 Compression point at output OP_{1dB} [dBm] = $f(I_C, V_{CE})$, $Z_S = Z_L = 50 \Omega$, $f = 2.4$ GHz

Electrical characteristics

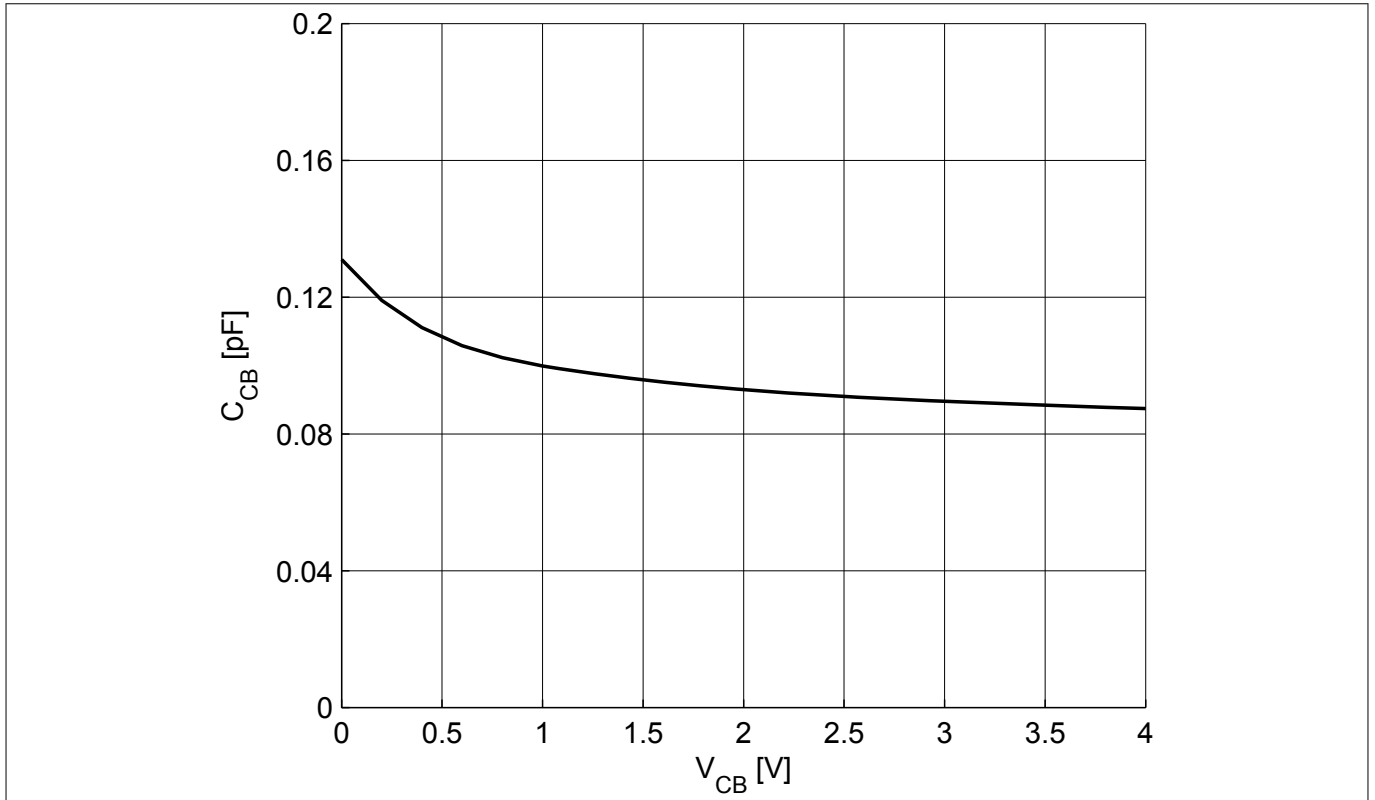

Figure 12 Collector base capacitance $C_{CB} = f(V_{CB})$, $f = 1$ MHz

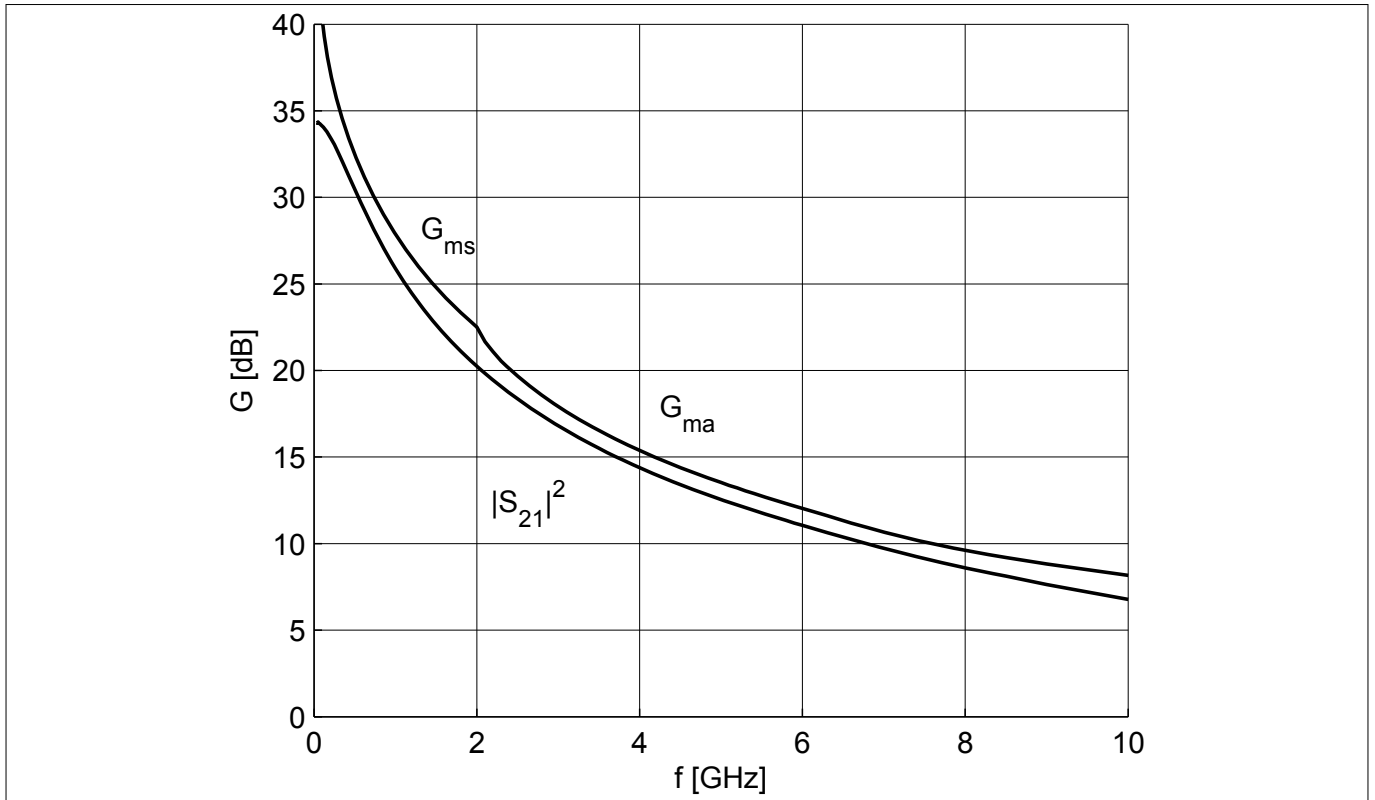

Figure 13 Gain G_{ma} , G_{ms} , $|S_{21}|^2 = f(f)$, $V_{CE} = 3$ V, $I_C = 25$ mA

Electrical characteristics

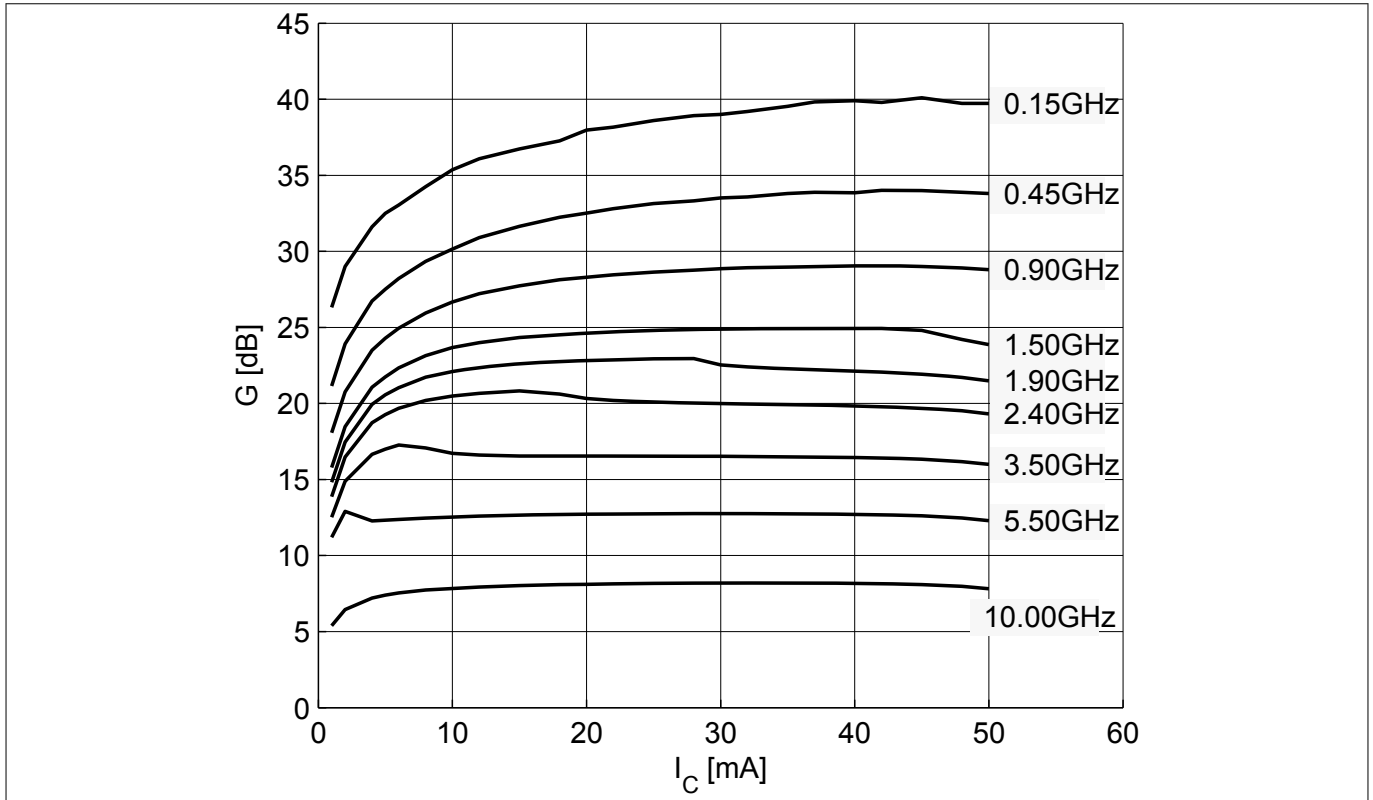

Figure 14 Maximum power gain $G_{max} = f(I_C)$, $V_{CE} = 3\text{ V}$, $f = \text{parameter in GHz}$

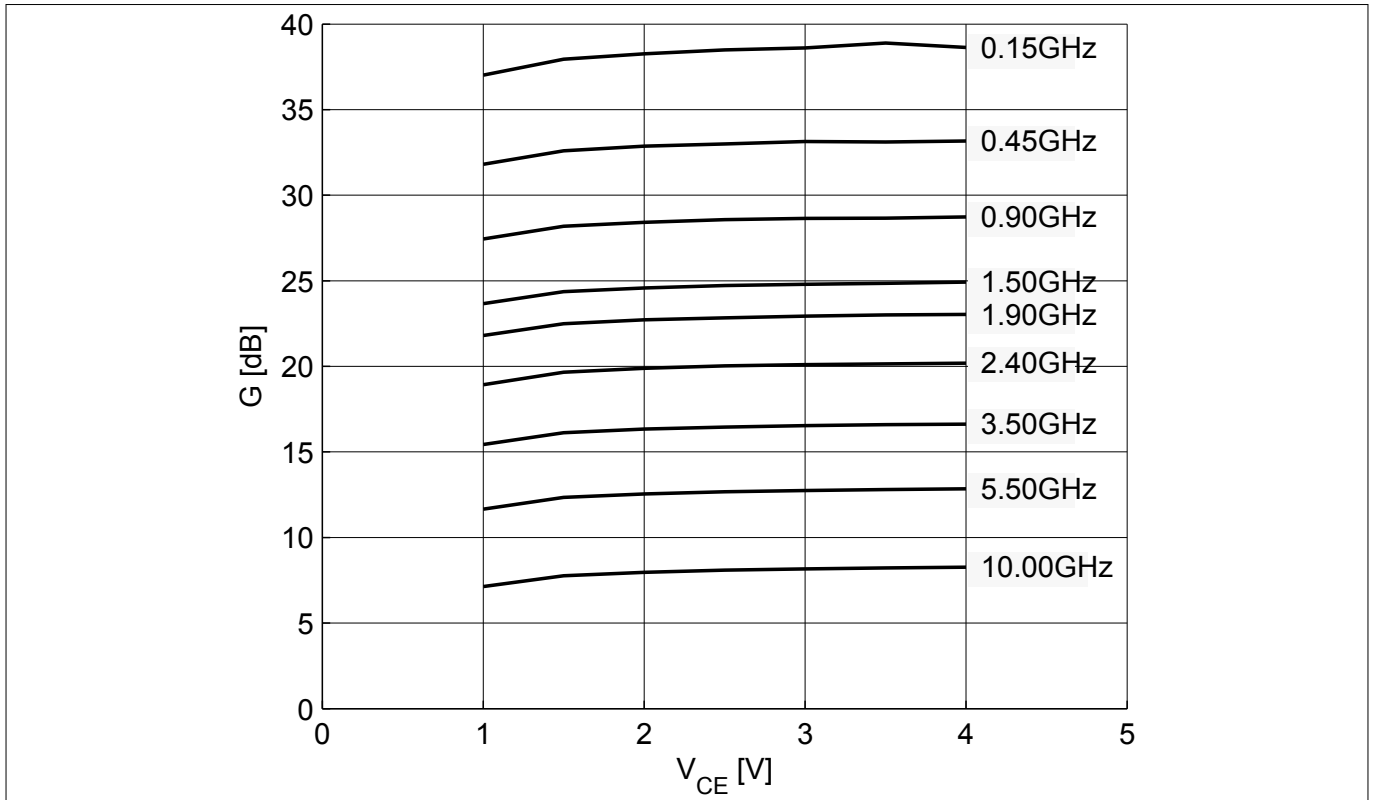

Figure 15 Maximum power gain $G_{max} = f(V_{CE})$, $I_C = 25\text{ mA}$, $f = \text{parameter in GHz}$

Electrical characteristics

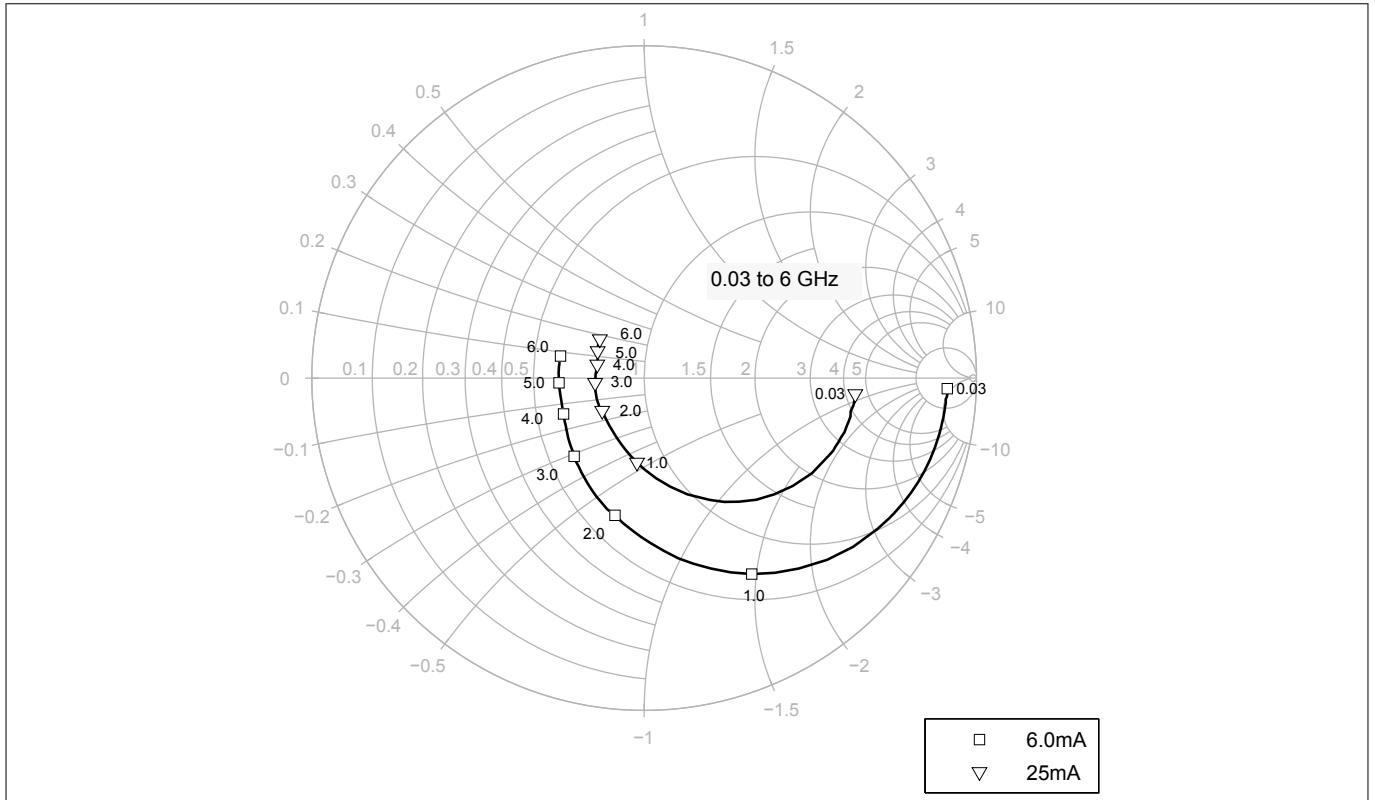

Figure 16 Input reflection coefficient $S_{11} = f(f)$, $V_{CE} = 3 \text{ V}$, $I_C = 6 / 25 \text{ mA}$

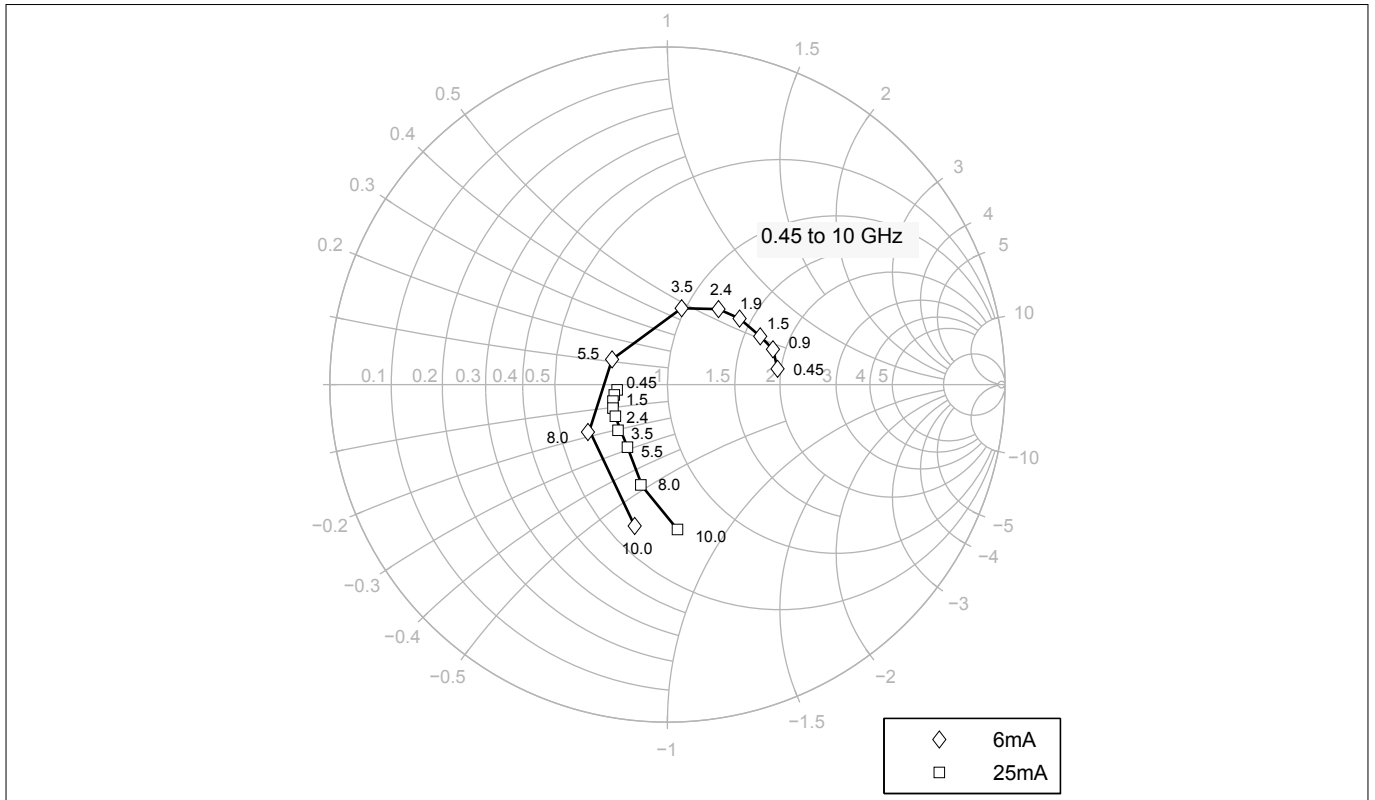

Figure 17 Source impedance for minimum noise figure $Z_{S,opt} = f(f)$, $V_{CE} = 3 \text{ V}$, $I_C = 6 / 25 \text{ mA}$

Electrical characteristics

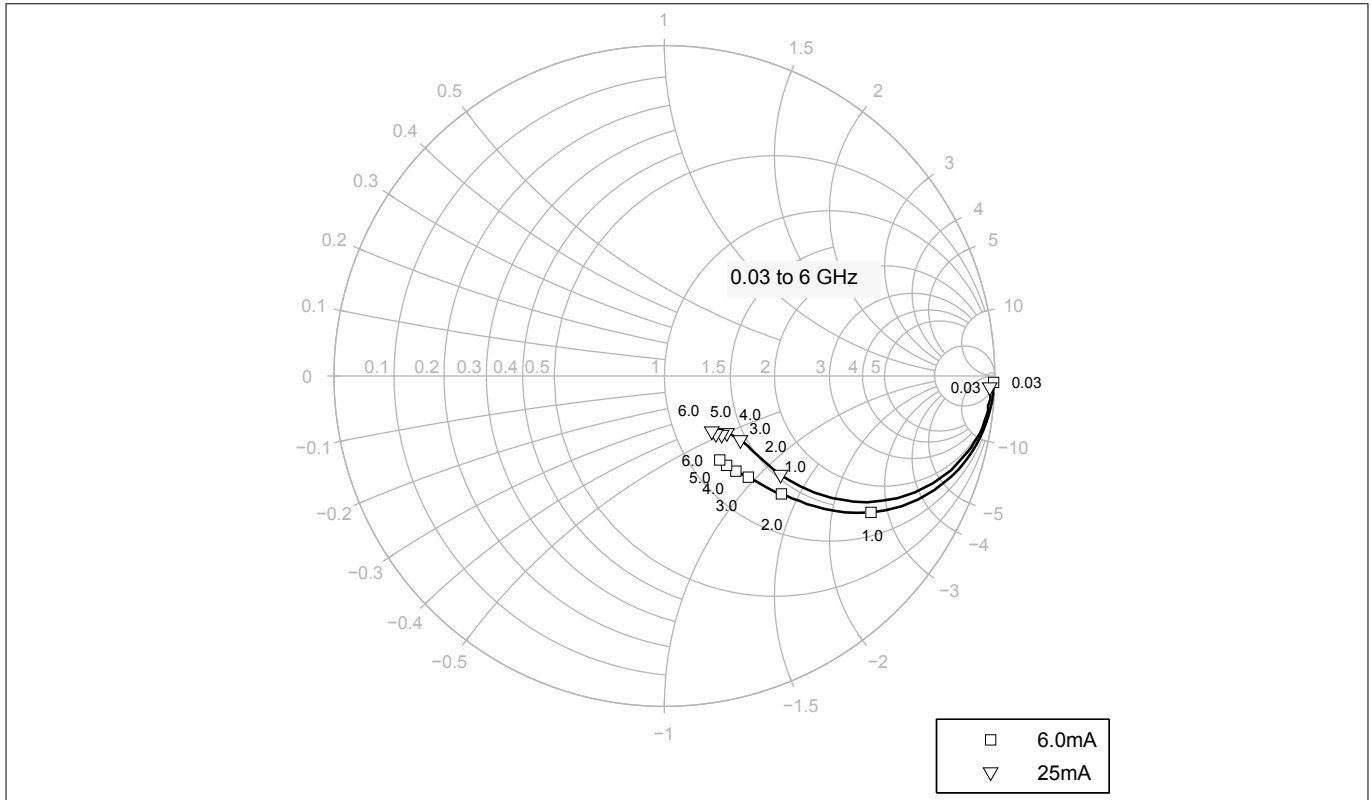

Figure 18 Output reflection coefficient $S_{22} = f(f)$, $V_{CE} = 3\text{ V}$, $I_C = 6 / 25\text{ mA}$

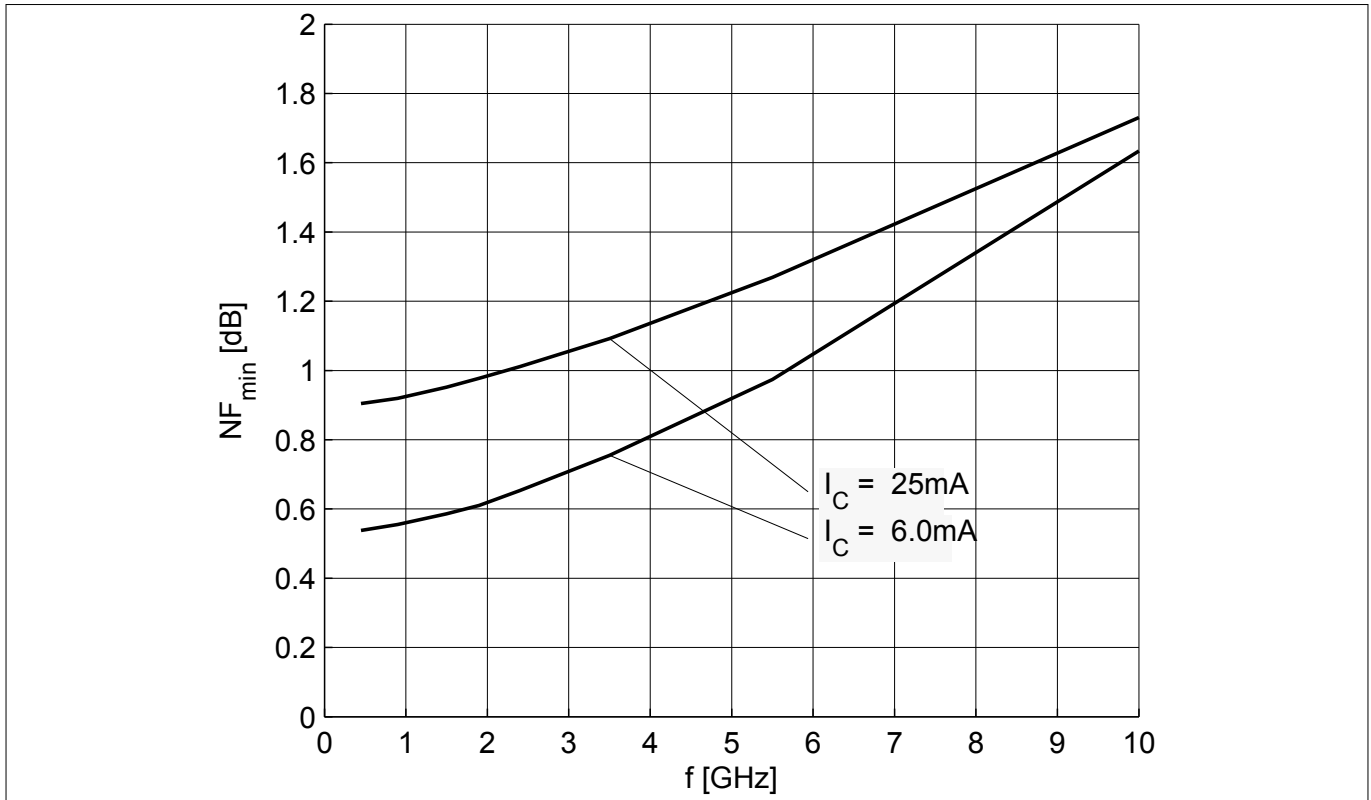

Figure 19 Noise figure $NF_{min} = f(f)$, $Z_S = Z_{S,opt}$, $V_{CE} = 3\text{ V}$, $I_C = 6 / 25\text{ mA}$

Electrical characteristics

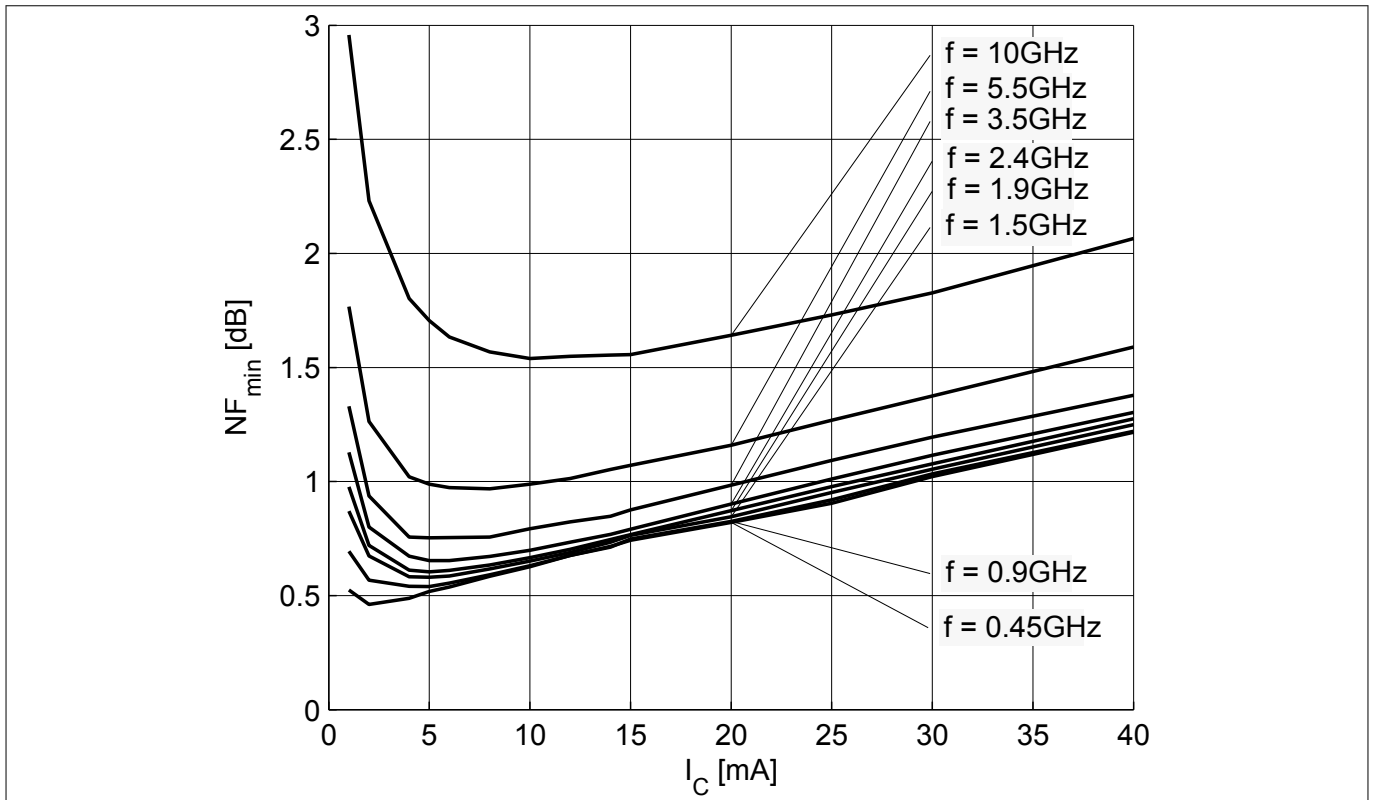

Figure 20 Noise figure $NF_{min} = f(I_C), Z_S = Z_{S,opt}, V_{CE} = 3\text{ V}, f = \text{parameter in GHz}$

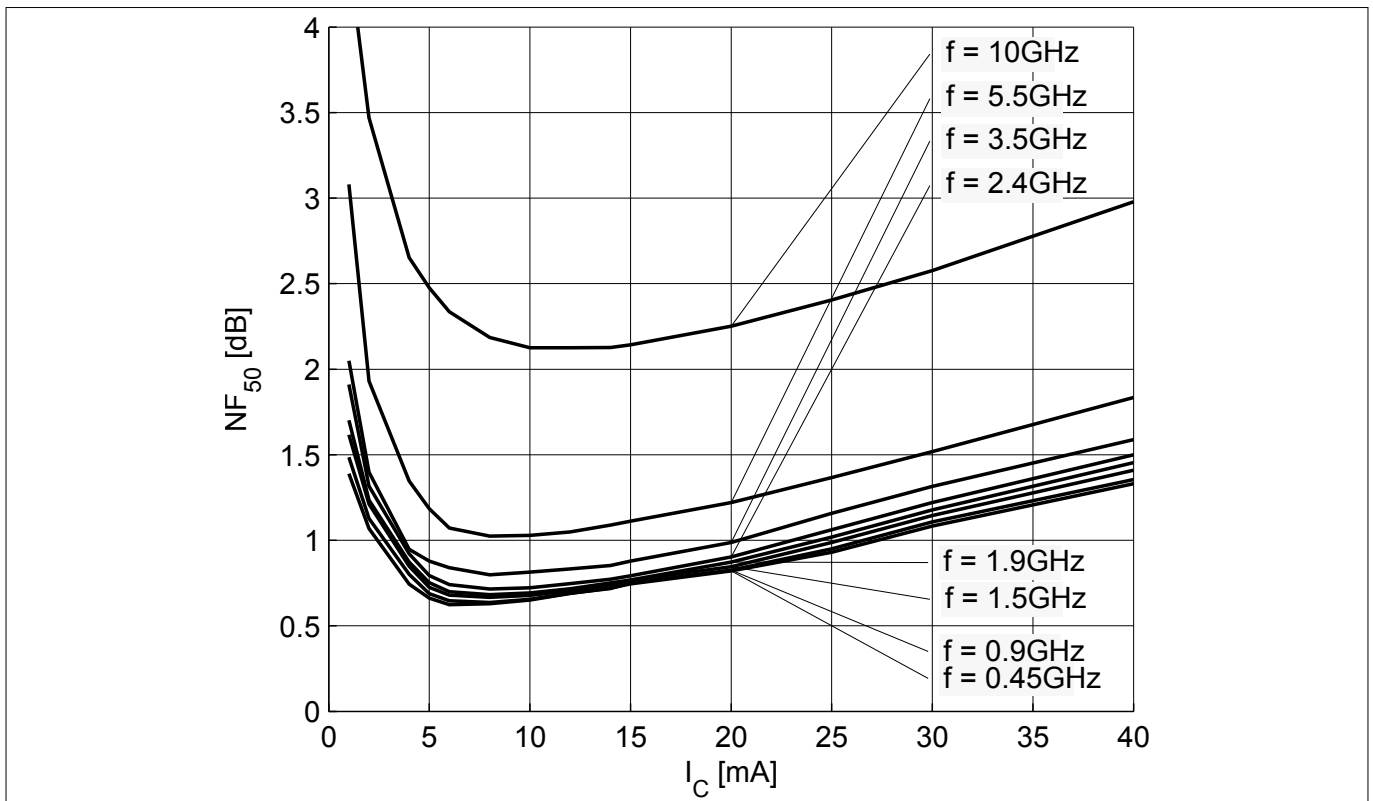

Figure 21 Noise figure $NF_{50} = f(I_C), Z_S = 50\ \Omega, V_{CE} = 3\text{ V}, f = \text{parameter in GHz}$

Note: The curves shown in this chapter have been generated using typical devices but shall not be considered as a guarantee that all devices have identical characteristic curves. $T_A = 25\text{ }^\circ\text{C}$.

Package information TSFP-4-1

4 Package information TSFP-4-1

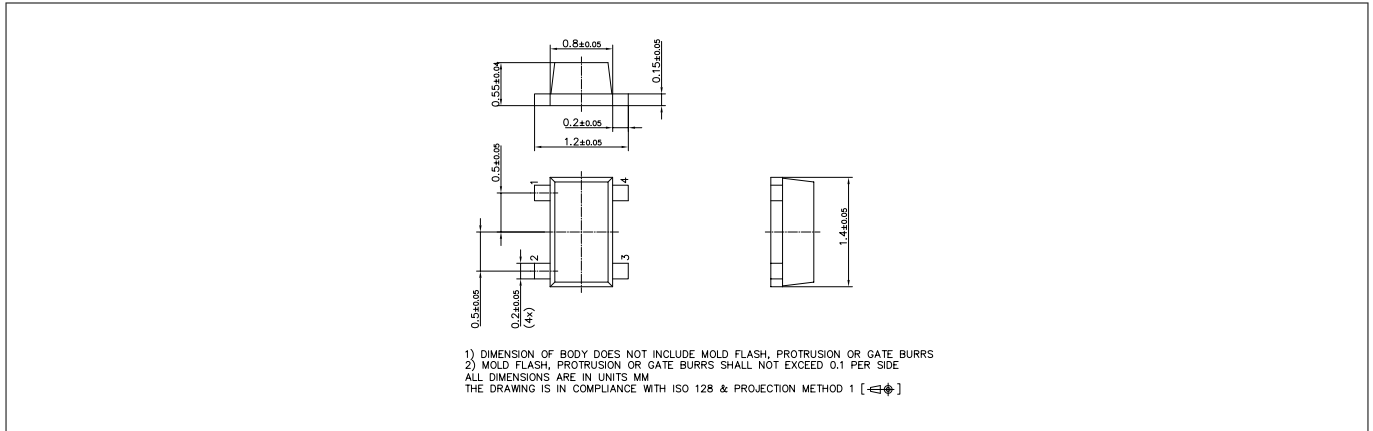

Figure 22 Package outline

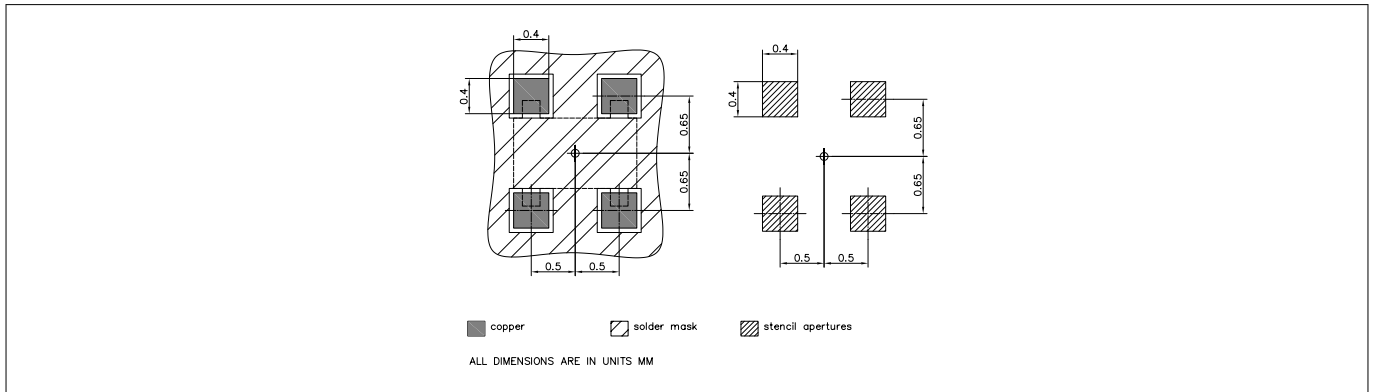

Figure 23 Foot print

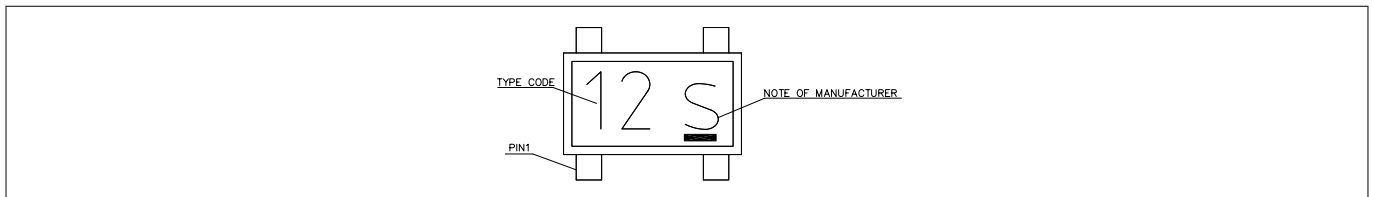

Figure 24 Marking layout example

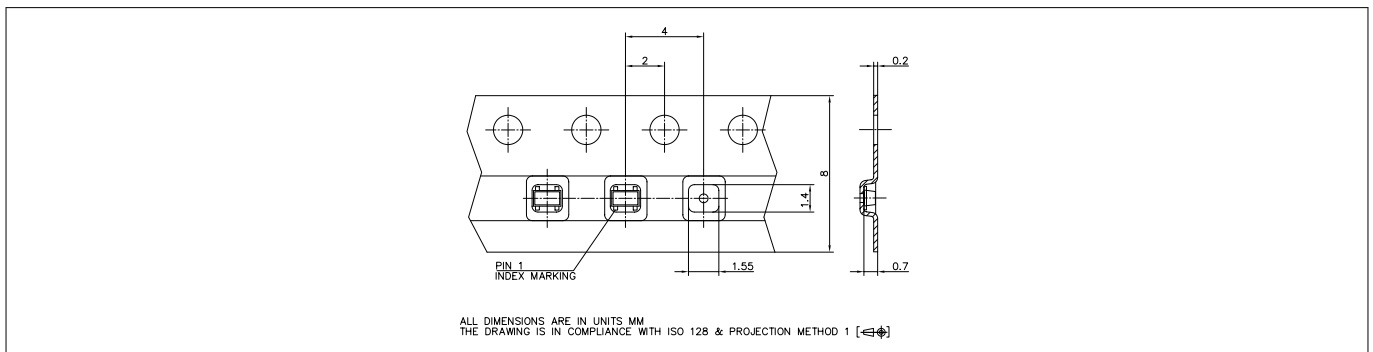

Figure 25 Tape dimensions

Revision history

Revision history

Document version	Date of release	Description of changes
Revision 3.0	2019-01-25	New datasheet layout.